



联系我们

昆山育崛教育器材有限公司



0512-50171266



sales@ksj-dac.com



www.ksj-dac.com



江苏省苏州市昆山市开发区金泰国际中心  
江苏省徐州市睢宁县八里工业园区

环保

健康

安全

功能

舒适

耐用

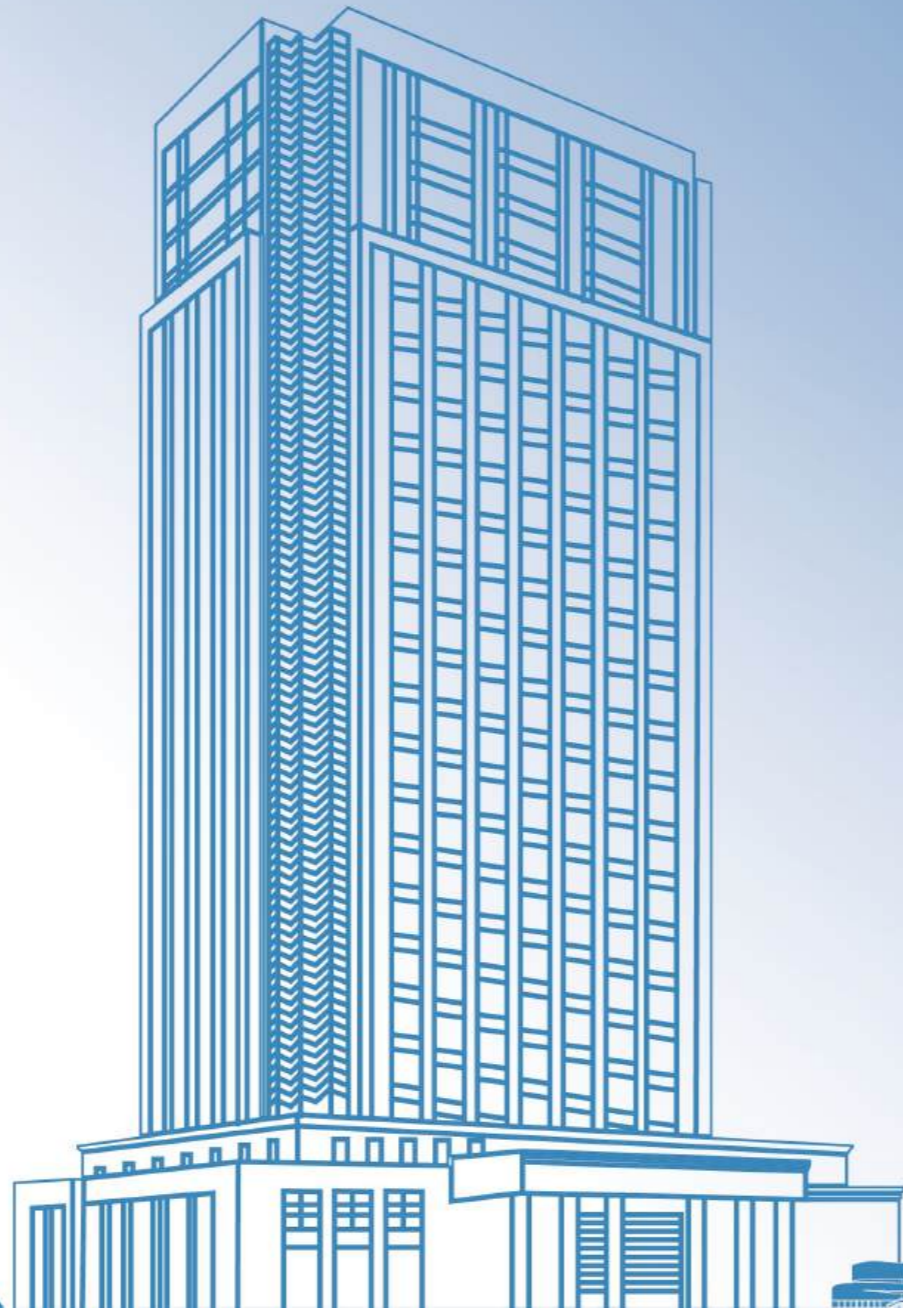

## 公司简介

Company Profile



昆山育崛教育器材有限公司坐落于中国国务院批准的国家级开发区—昆山经济技术开发区。因产能扩张需要，2019年在江苏省徐州市睢宁县八里工业园区成立江苏育崛教育设备有限公司。生产基地占地面积达33,000平方米。

我们是专注于为学校提供整体教育装备解决方案的公司。我们的使命是创造优质的教学环境，为师生打造舒适、安全、具有启发性的学习空间。我们的服务涵盖方案设计、空间布局规划、视觉直观呈现，以及全面的整体方案制定。从项目规划到施工完成，我们提供专业可靠的服务。我们高度重视产品的安全、专业和环保特性，确保我们的解决方案能够充分满足学校的需求。

中国教育装备行业协会

会员企业

江苏省教育装备行业协会

会员企业





## 产品质量认证和检测报告

### 我们的产品质量保证



### 课桌椅面板(ABS)- 有害物质检测报告{合格}

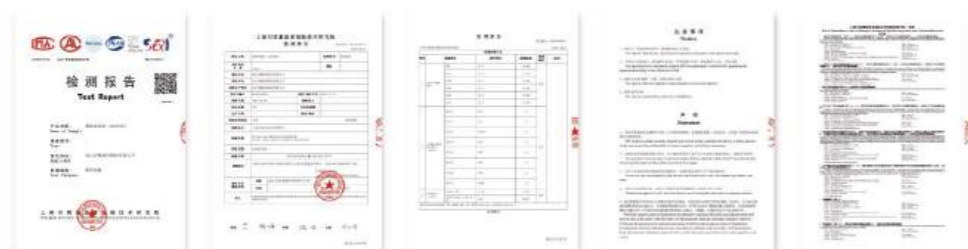

### 课桌椅(PP)- 有害物质检测报告{合格}



## CATALOGUE 目录

### 午休课桌椅

Siesta Chair

P1-P6

### 可调节课桌椅

Height Adjustable Desk & Chair for Students

P7-P20

### 固定式课桌椅

Fixed Desk & Chair for Students

P21-P23

### 拼桌

Collaborative Table

P24-P37

### 餐桌

Dining Table

P38-P43

### 凳子

Stool

P44-P46

### 教室配套柜

Classroom Cabinet

P47-P59

### 专用教室方案

Function Room & Subject Classroom

P60-P80

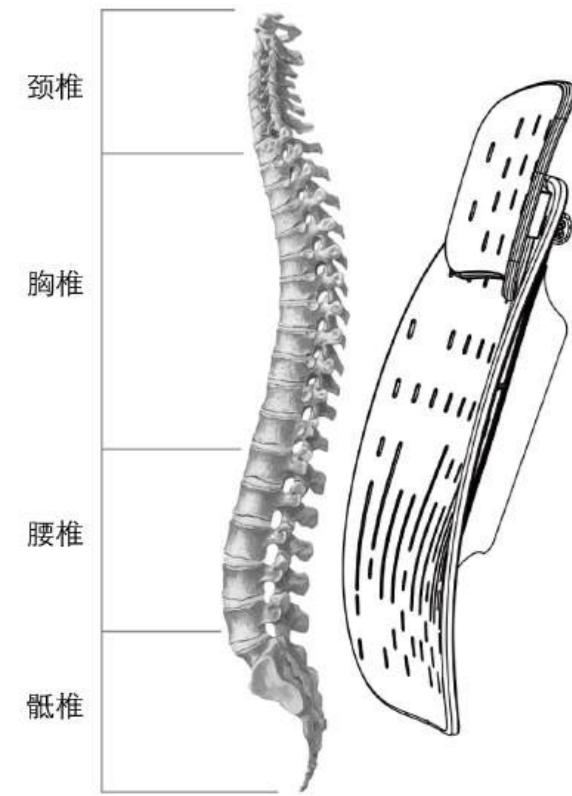

## 靠背设计

### 人体工学理念设计

靠背参考人体工学理念设计,凹陷部位贴合胸椎包覆并定型,凸起部位支撑腰椎!



## 人体工学理念设计

人类脊柱由33块椎骨(颈椎7块,胸椎12块,腰椎5块,骶骨、尾骨共9块)借韧带、关节及椎间盘连接而成。脊柱上端承托颅骨,下联髌骨,中附肋骨,并作为胸廓、腹腔和盆腔的后壁。脊柱具有支持躯干、保护内脏、保护脊髓和进行运动的功能。脊柱内部自上而下形成一条纵行的脊管,内有脊髓。



www.ksyj-dac.com

## 午休课桌椅

Siesta Chair



### 午休课桌椅

Height Adjustable  
Siesta Chair for Students



### 午休课桌椅

Height Adjustable  
Desk & Chair for Students

升降方式	手摇
产品型号	YJ-WS2561
主要材质	ABS/PP/碳钢
颜色选配	
应用场景	普通教室

为孩子的成长量身定“座”  
Tailored Seats for Children



午休课桌椅  
Siesta Chair



为孩子的成长量身定“座”  
Tailored Seats for Children



## 可调节课桌椅

Height Adjustable  
Desk & Chair for Students



励 志 唯 实

尚 学 强 能

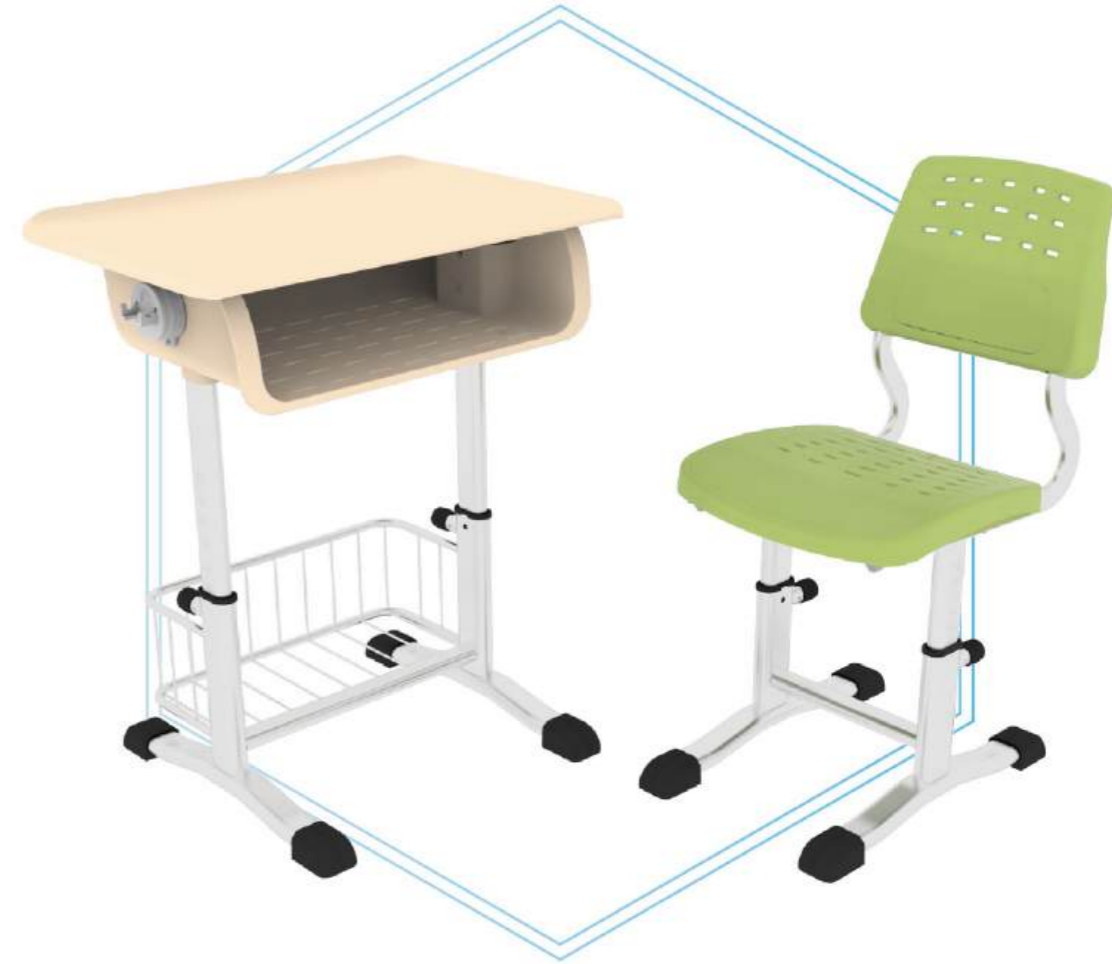

## 可调节课桌椅

Height Adjustable  
Desk & Chair for Students



升降方式	旋钮/手摇/螺丝
产品型号	YJ-Z1332N3
主要材质	ABS/PP/碳钢
颜色选配	
应用场景	普通教室



### 可调节课桌椅

Height Adjustable  
Desk & Chair for Students

### 长颈鹿 Giraffe

升降方式	可调节式塑钢课桌椅
产品型号	YJ-ZT3N8_N6
主要材质	ABS/PP/碳钢
颜色选配	
应用场景	普通教室



为孩子的成长量身定“座”  
Tailored Seats for Children



### 可调节课桌椅

Height Adjustable  
Desk & Chair for Students

简易风  
Minimalism

螺栓调节	可调节式塑钢课桌椅
产品型号	YJ-ZLN610N5
主要材质	ABS/PP/碳钢
颜色选配	
应用场景	普通教室

为孩子的成长量身定“座”  
Tailored Seats for Children



### 可调节课桌椅

Height Adjustable  
Desk & Chair for Students

### 欧式 European Style

升降方式	旋钮/手摇/螺丝
产品型号	YJ-Z136C2_N1
主要材质	ABS/PP/碳钢
颜色选配	
应用场景	普通教室

为孩子的成长量身定“座”  
Tailored Seats for Children

## 可调节课桌椅

Height Adjustable  
Desk & Chair for Students



### 竹元素 Bamboo

升降方式	旋钮/手摇/螺丝
产品型号	YJ-Z132_N4
主要材质	ABS/PP/碳钢
颜色选配	
应用场景	普通教室



## 可调节课桌椅

Height Adjustable  
Desk & Chair for Students

### 蝴蝶 Butterfly

升降方式	旋钮/螺丝
产品型号	YJ-Z212_
主要材质	ABS/PP/碳钢
颜色选配	
应用场景	普通教室

## 可调节课桌椅

Height Adjustable  
Desk & Chair for Students



### 大靠背大坐垫 Large Seats

升降方式	旋钮/手摇/螺丝
产品型号	YJ-G1325
主要材质	ABS/PP/碳钢
颜色选配	
应用场景	普通教室



## 可调节课桌椅

Height Adjustable  
Desk & Chair for Students

### 课桌凳 Desk & Stool

升降方式	旋钮/螺丝
产品型号	YJ-ZT2164FD
主要材质	ABS/PP/碳钢
颜色选配	
应用场景	普通教室



为孩子的成长量身定“座”  
Tailored Seats for Children

## 可调节课桌椅

Height Adjustable  
Desk & Chair for Students



美术桌椅  
Art Table & Chair

升降方式	旋钮/手摇/螺丝
产品型号	YJ-MS13610N1
主要材质	ABS/PP/碳钢
颜色选配	
应用场景	普通教室

## 使用身高参考:

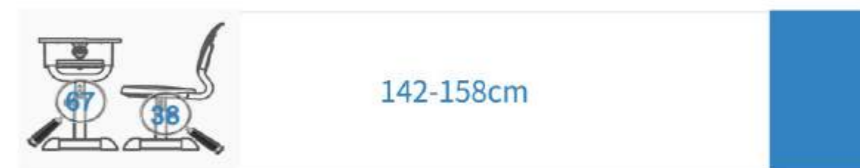

为孩子的成长量身定“座”  
Tailored Seats for Children



## 固定式课桌椅

Fixed Desk  
& Chair for Students



## 固定式课桌椅

Fixed Desk  
& Chair for Students

H桌  
H Style

固定高度	固定式塑钢课桌椅
产品型号	YJ-G4H25/YJ-G4L25
主要材质	ABS/PP/碳钢
颜色选配	
应用场景	普通教室

## 固定式课桌椅

Fixed Desk  
& Chair for Students



### K桌 K Style

固定高度	固定式塑钢课桌椅
产品型号	YJ-G4K21/YJ-G4S21
主要材质	ABS/PP/碳钢
颜色选配	
应用场景	普通教室

## 拼桌

Collaborative Table

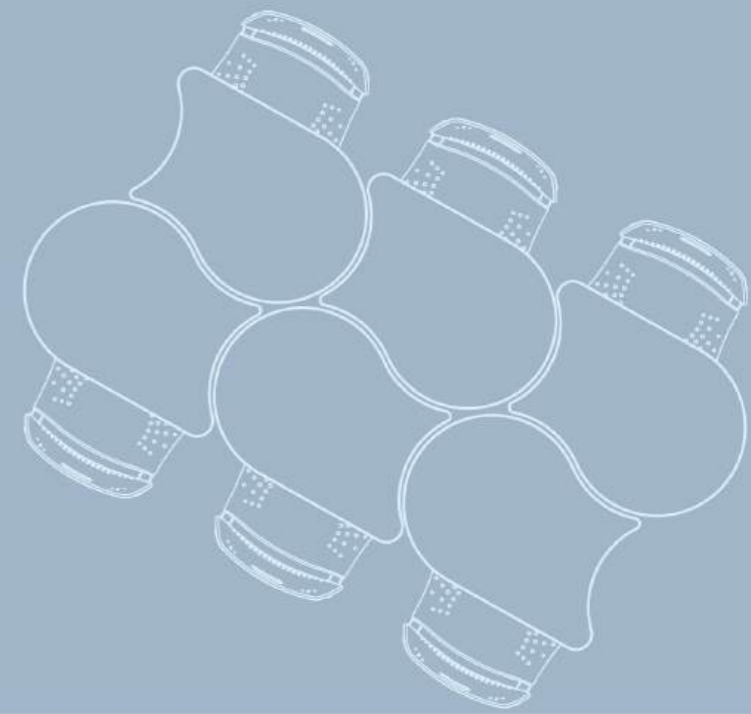
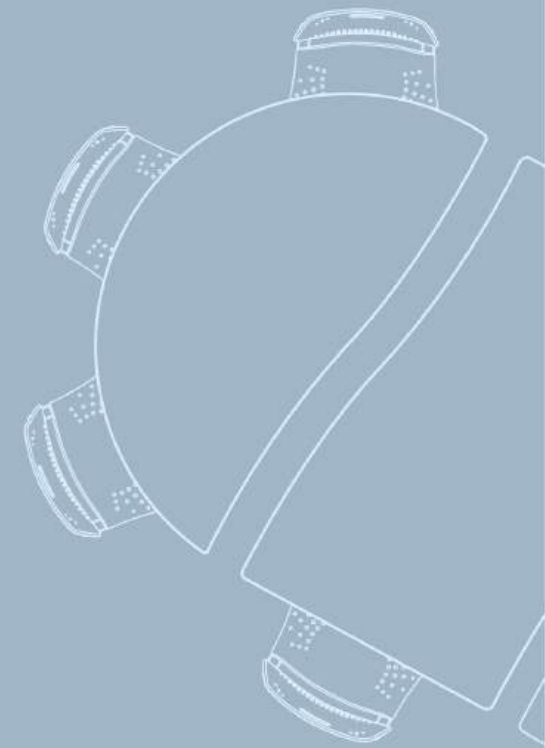
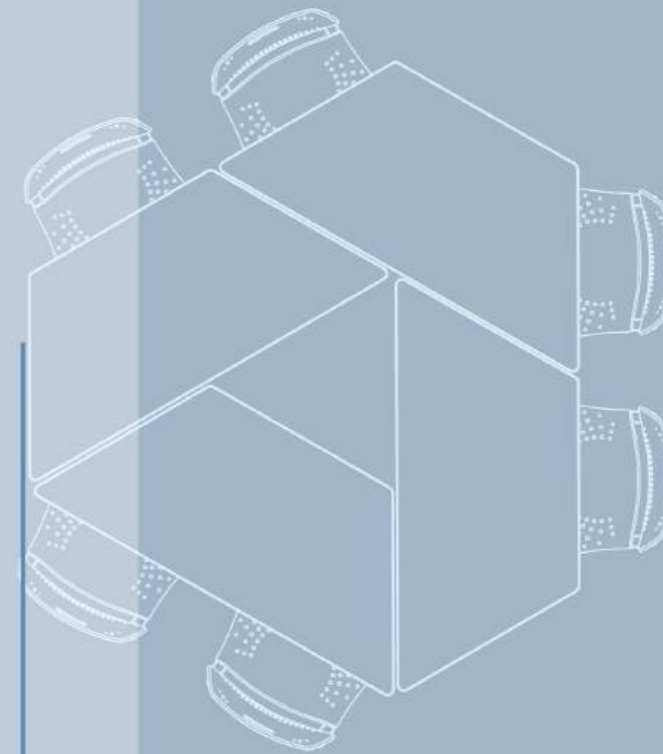
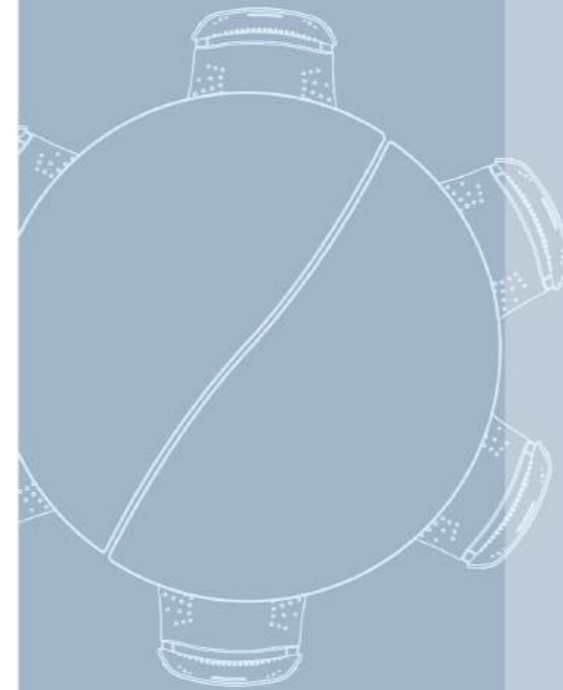

为孩子的成长量身定“座”  
Tailored Seats for Children



拼桌

Collaborative Table

R型拼桌  
R Type



可选桌腿	调节/固定/带轮
产品型号	YJ-Q502_R
主要材质	抗倍特或吸塑桌面/碳钢
应用场景	活动教室



为孩子的成长量身定“座”  
Tailored Seats for Children



### 拼桌

Collaborative Table

### 梯型拼桌

Trapezoid Type

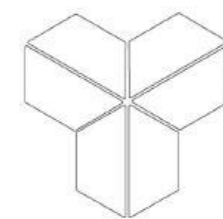
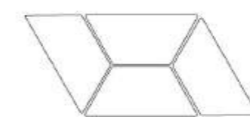
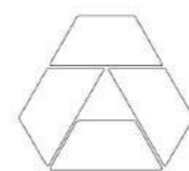

可选桌腿	调节/固定/带轮
产品型号	YJ-Q402_T
主要材质	抗倍特或吸塑桌面/碳钢
应用场景	活动教室

为孩子的成长量身定“座”  
Tailored Seats for Children



拼桌

Collaborative Table

半圆&波浪拼桌  
Semicircle & Wavy Type



可选桌腿	调节/固定/带轮
产品型号	YJ-Q402_C / YJ-Q402_W
主要材质	抗倍特或吸塑桌面/碳钢
应用场景	活动教室

## 拼桌

Collaborative Table



菱形拼桌  
Diamond Type

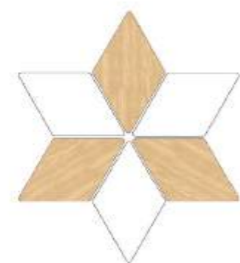

可选桌腿	调节/固定/带轮
产品型号	YJ-Q402_3
主要材质	抗倍特或吸塑桌面/碳钢
应用场景	活动教室

## 拼桌

Collaborative Table



四叶草形拼桌  
Four Leaf Clover

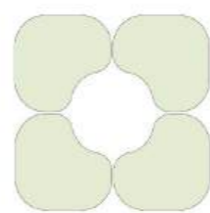

可选桌腿	调节/固定/带轮
产品型号	YJ-Q402_L
主要材质	抗倍特或吸塑桌面/碳钢
应用场景	活动教室

### 拼桌

Collaborative Table



钻石拼桌  
Diamond Type

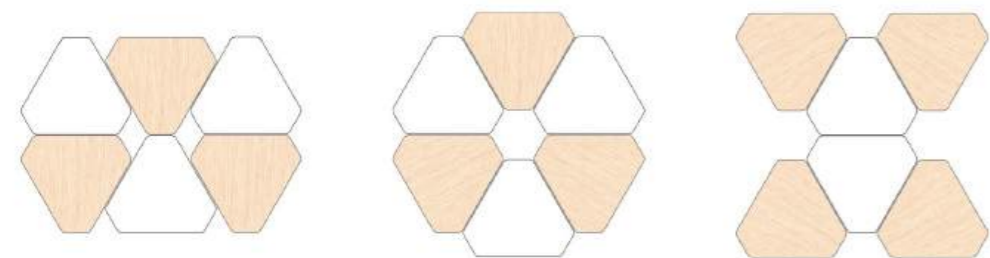

可选桌腿	调节/固定/带轮
产品型号	YJ-Q402_D
主要材质	抗倍特或吸塑桌面/碳钢
应用场景	活动教室



皂形拼桌  
Soap Type

### 拼桌

Collaborative Table



可选桌腿	调节/固定/带轮
产品型号	YJ-Q402_4
主要材质	抗倍特或吸塑桌面/碳钢
应用场景	活动教室

## 拼桌

Collaborative Table



鱼形拼桌  
Fish Type

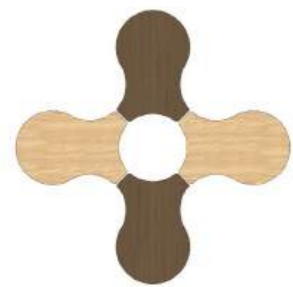

可选桌腿	调节/固定/带轮
产品型号	YJ-Q402_F
主要材质	抗倍特或吸塑桌面/碳钢
应用场景	活动教室

## 拼桌

Collaborative Table



盾形拼桌  
Shield Type

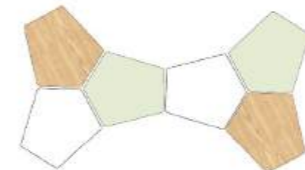

可选桌腿	调节/固定/带轮
产品型号	YJ-Q402_S
主要材质	抗倍特或吸塑桌面/碳钢
应用场景	活动教室

## 拼桌

Collaborative Table



月亮形拼桌  
Moon Type

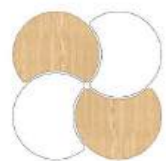

可选桌腿	调节/固定/带轮
产品型号	YJ-Q402_1
主要材质	抗倍特或吸塑桌面/碳钢
应用场景	活动教室



## 餐桌

Dining Table

为孩子的成长量身定“座”  
Tailored Seats for Children

M



餐桌  
Dining Table



餐桌  
Convertible Dining Table

回旋式	收纳餐桌
产品型号	YJ-C708_4
主要材质	ABS/碳钢/抗倍特
产品规格	600W / 700W*750H



U形固定式4人餐桌  
U4 Dining Table

产品型号	YJ-U408_4
主要材质	ABS/碳钢/抗倍特
产品规格	1200L*600W*750H

餐桌  
Dining Table



U形固定式8人餐桌  
U8 Dining Table

回旋式	收纳餐桌
产品型号	YJ-U708_4
主要材质	ABS/碳钢/抗倍特
产品规格	600W / 700W*750H



为孩子的成长量身定“座”  
Tailored Seats for Children



## 餐桌

Dining Table

## 简易款餐桌 Dining Table

产品型号	YJ-C408_4
主要材质	ABS/碳钢/抗倍特
产品规格	1200L*600W*750H



Stool



## 凳子

Stool



圆凳  
Round Stool

产品名称	可堆叠圆凳
产品型号	YJ-Y0627/YJ-T0627
主要材质	ABS/PP/碳钢
颜色选配	
应用场景	活动教室/专科教室



## 凳子

Stool



圆凳  
Round Stool

产品名称	可挂放圆凳
产品型号	YJ-STH01
主要材质	ABS/PP/碳钢
颜色选配	
应用场景	活动教室/专科教室

为孩子的成长量身定“座”  
Tailored Seats for Children



# 教室配套柜

Cabinets



## 教室配套柜

Classroom Cabinet



收纳储物柜  
Storage  
多功能收纳盒  
Plastic Drawer

产品名称	书包柜组合
主要材质	E1级别环保整体板/PP塑料
应用场景	普通教室

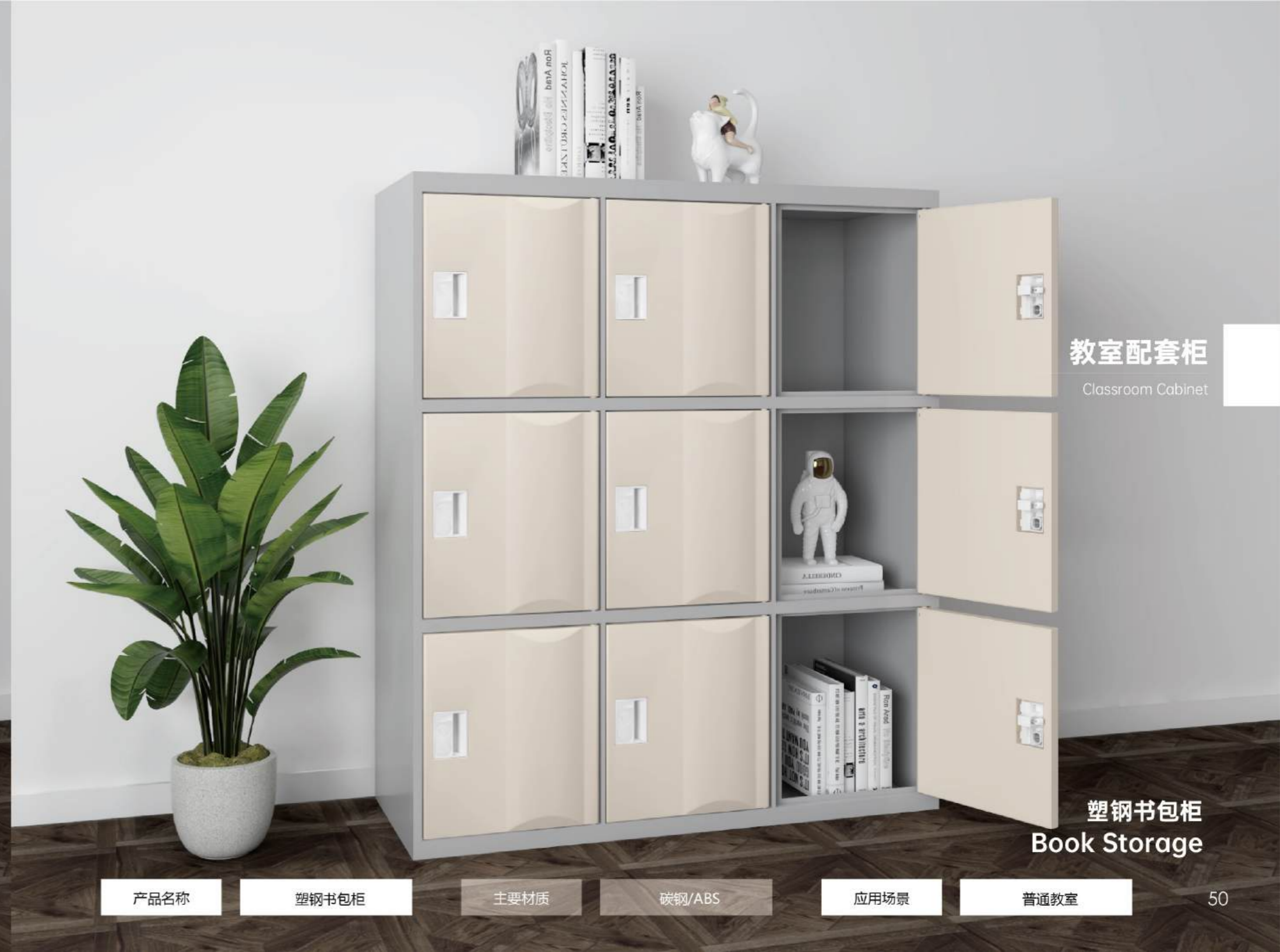

教室配套柜

Classroom Cabinet

塑钢书包柜  
Book Storage

产品名称

塑钢书包柜

主要材质

碳钢/ABS

应用场景

普通教室

为孩子的成长量身定“座”  
Tailored Seats for Children

## 教室配套柜

Classroom Cabinet



## 批阅桌 Teacher Desk

产品名称	批阅桌
主要材质	抗倍特板
应用场景	普通教室



## 教室配套柜

Classroom Cabinet



## 打扫用具柜 Cleaning Tool Cabinet

产品名称	打扫用具柜
主要材质	E1级别环保整体板
应用场景	普通教室

## 专用教室配套柜

Classroom Cabinet



收纳柜  
Cabinet

产品名称	收纳柜
主要材质	E1级别环保整体板
应用场景	专用教室



收纳柜  
Cabinet

产品名称	收纳柜
主要材质	E1级别环保整体板
应用场景	专用教室

## 专用教室配套柜

Classroom Cabinet

## 专用教室配套柜

Classroom Cabinet



收纳柜  
Cabinet

产品名称	收纳柜
主要材质	E1级别环保整体板
应用场景	专用教室



收纳柜  
Cabinet

产品名称	收纳柜
主要材质	E1级别环保整体板
应用场景	专用教室

## 教室配套柜

Classroom Cabinet

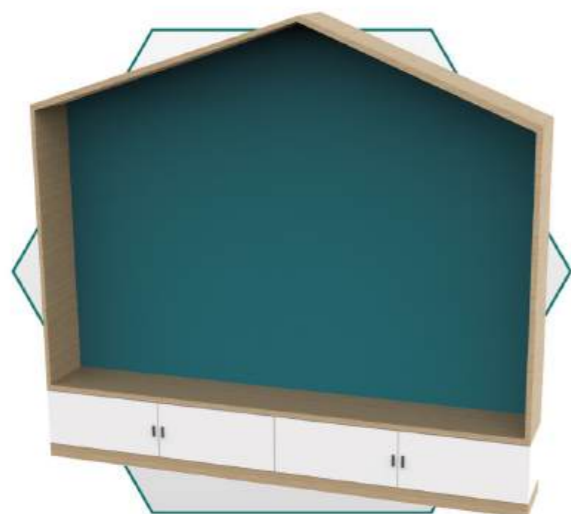

## 图书角 Library Corner

产品名称	图书角
主要材质	E1级别环保整体板
应用场景	普通教室

## 教室配套柜

Classroom Cabinet



## 作业柜 Homework Cabinet

产品名称	作业柜
主要材质	E1级别环保整体板
应用场景	普通教室



为孩子的成长量身定“座”  
Tailored Seats for Children



### 专用教室配套柜

Classroom Cabinet

### 专用教室柜 Special Classroom Cabinet

产品名称	专用教室柜
主要材质	E1级别环保整体板
应用场景	专用教室



### 专用教室方案 Stool





## 专用教室方案

Function Room  
& Subject Classroom

## 音乐教室 Music Classroom

旋转调节	可调节式塑钢音乐专用桌椅
产品型号	YJ-YY212_N2
主要材质	ABS/PP/碳钢
应用场景	音乐教室

为孩子的成长量身定“座”  
Tailored Seats for Children



## 专用教室方案

Function Room  
& Subject Classroom



美术教室

Art Classroom

旋转调节

固定式塑钢美术专用桌椅

产品型号

YJ-YY212\_N2

主要材质

MDF板/PP/PA/碳钢

应用场景

音乐教室

为孩子的成长量身定“座”  
Tailored Seats for Children



## 专用教室方案

Function Room  
& Subject Classroom

## 音乐教室 Music Classroom

旋转调节	可调节式塑钢音乐专用桌椅
产品型号	YJ-YY212_N2
主要材质	ABS/PP/碳钢
应用场景	音乐教室

为孩子的成长量身定“座”  
Tailored Seats for Children



## 专用教室方案

Function Room  
& Subject Classroom

## 美术教室 Art Classroom

手摇调节	可调节式塑钢美术专用桌椅
产品型号	YJ-MS2429
主要材质	吸塑板/PP/碳钢
颜色选配	<input type="checkbox"/> <input checked="" type="checkbox"/>
应用场景	美术教室

为孩子的成长量身定“座”  
Tailored Seats for Children



## 专用教室方案

Function Room  
& Subject Classroom

产品名称

多功能旋转椅

主要材质

抗倍特板/PP/PA/碳钢

应用场景

专用教室

为孩子的成长量身定“座”  
Tailored Seats for Children

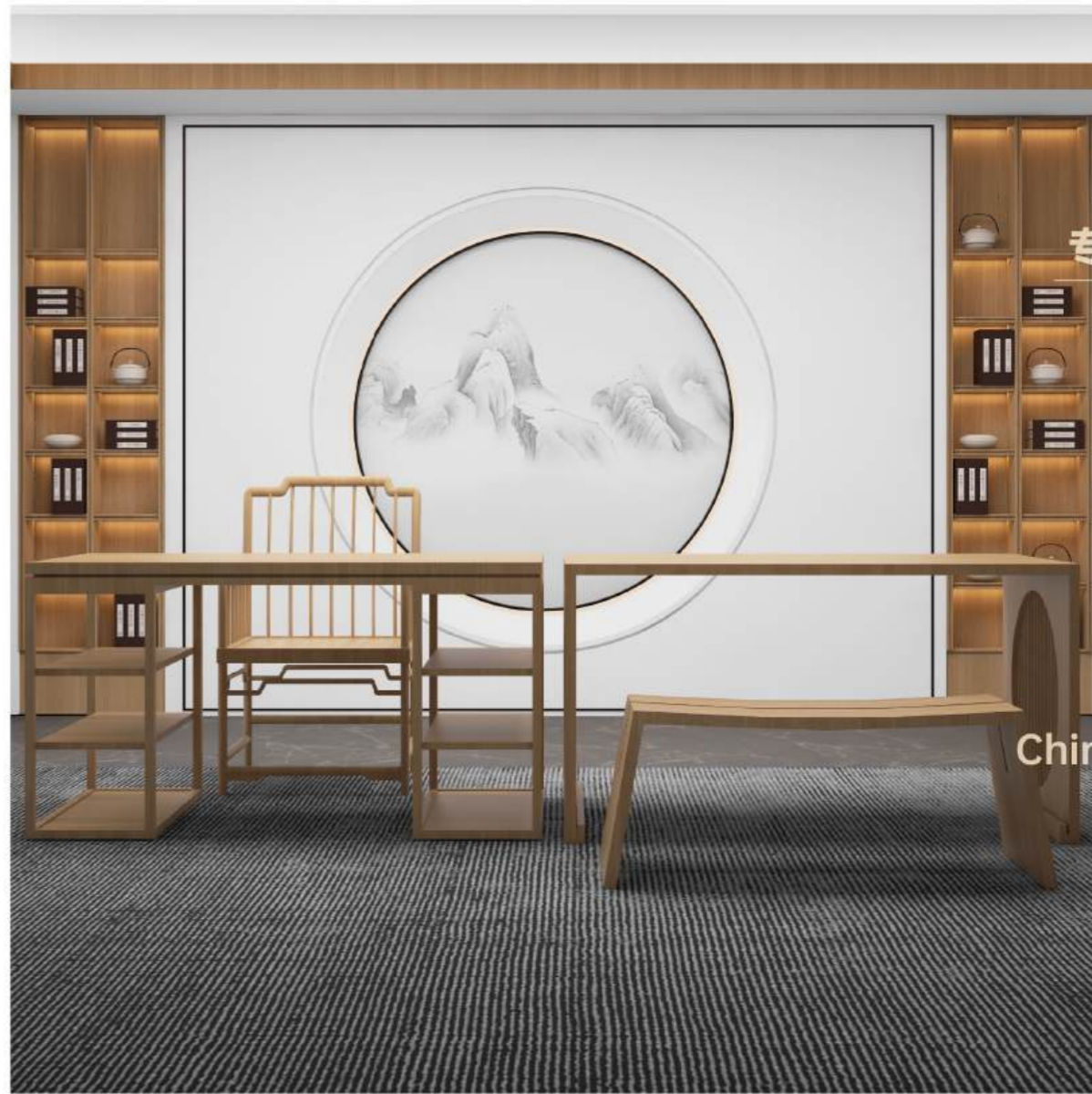

### 专用教室方案

Function Room  
& Subject Classroom

### 国学教室

Chinese Studies  
Classroom

产品型号

左边YJ-GX003 / 右边YJ-GX004

产品规格

1400L\_800W\_750H  
1400L\_750W\_750H

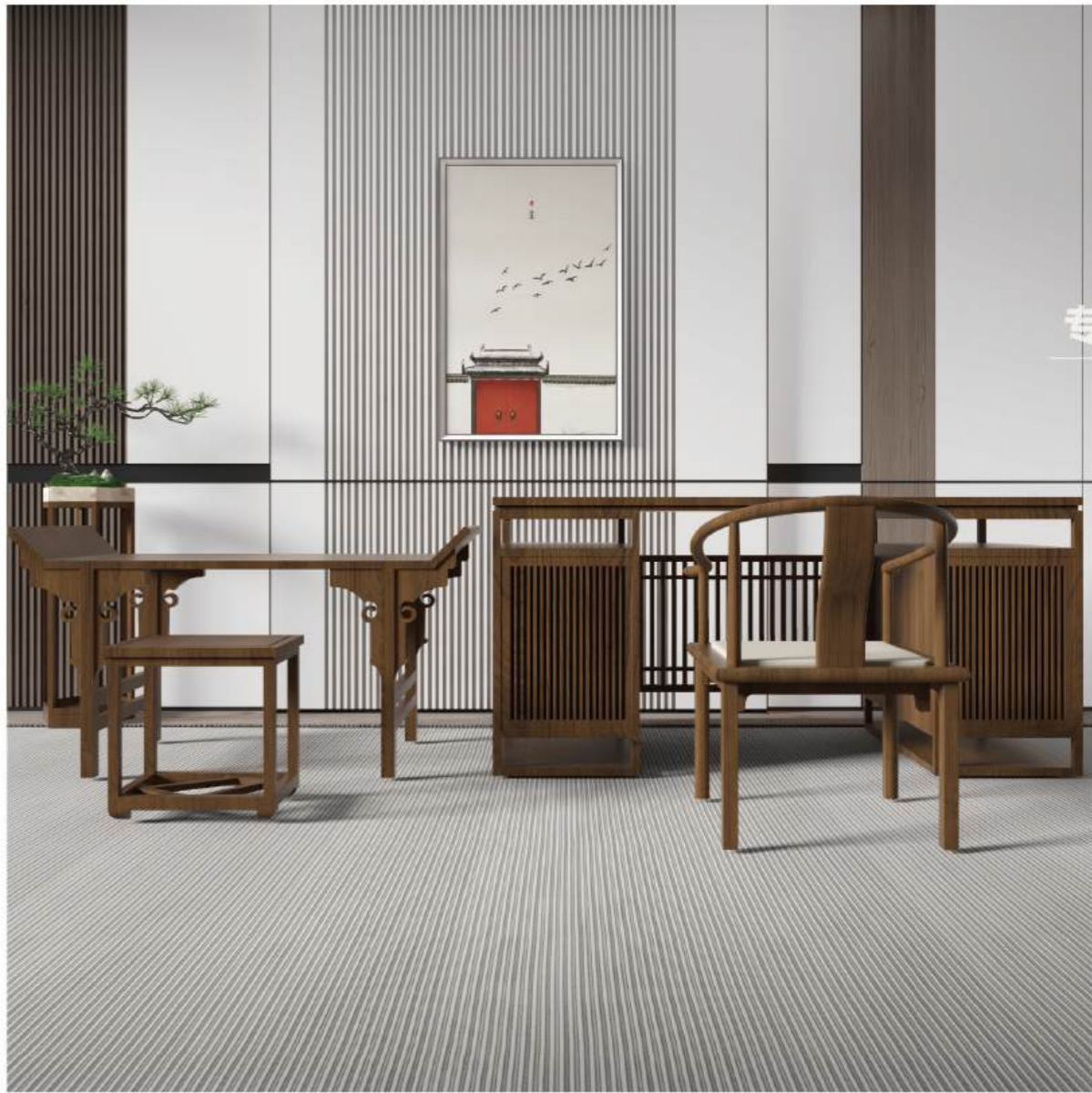

### 专用教室方案

Function Room  
& Subject Classroom

书法教室  
Calligraphy  
Classroom

产品型号

左边YJ-SF003 / 右边 SF004

产品规格

1400L\_600W\_750H  
1800L\_800W\_850H



为孩子的成长量身定“座”  
Tailored Seats for Children

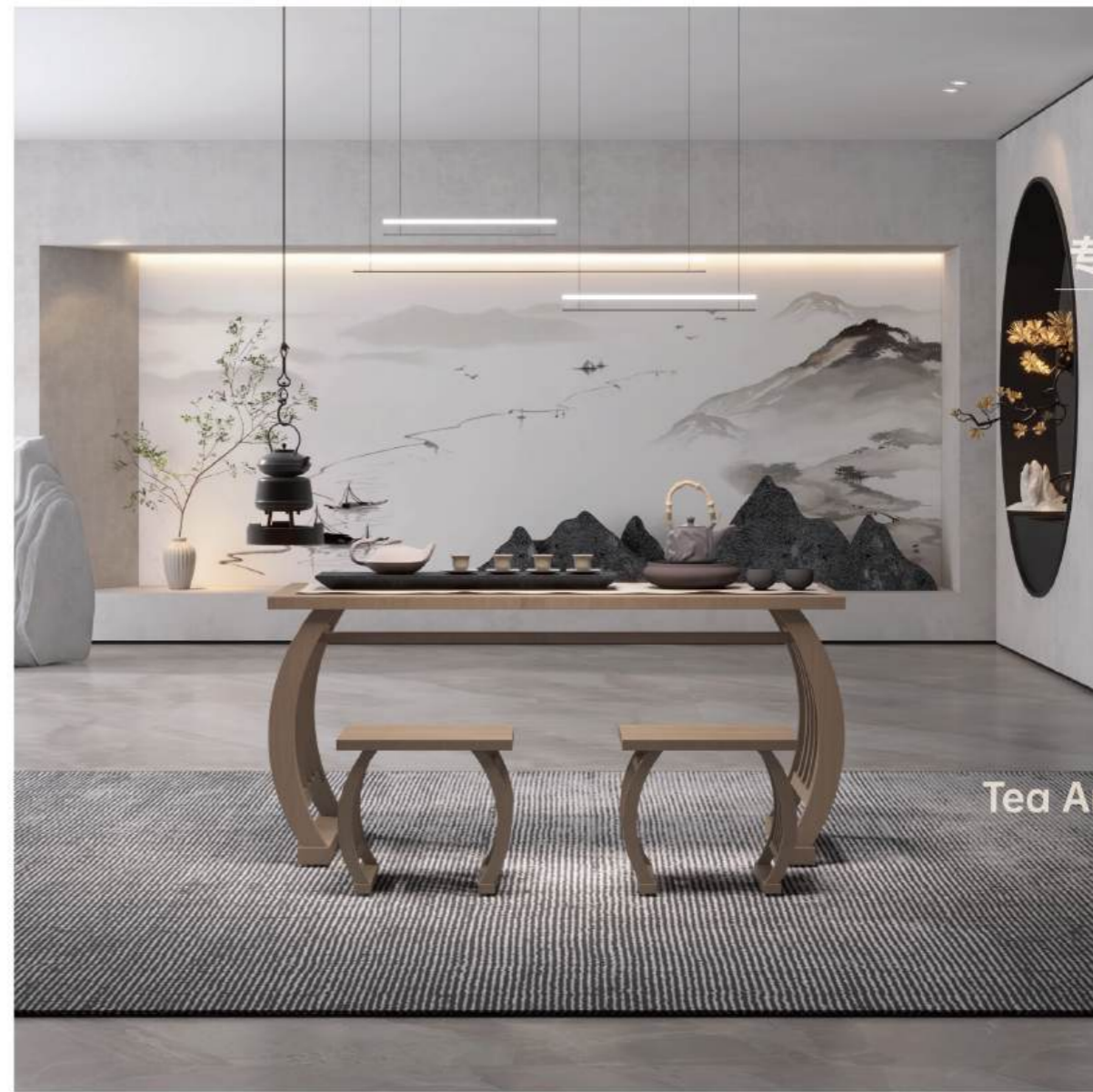

专用教室方案

Function Room  
& Subject Classroom

茶艺教室

Tea Art Classroom

产品型号

YJ-CY001

产品规格

1400L\_600W\_650H

为孩子的成长量身定“座”  
Tailored Seats for Children



## 专用教室方案

Function Room  
& Subject Classroom



会议室  
Meeting Room

产品型号

YJ-HY001

产品规格

1430L\_520W\_725H

为孩子的成长量身定“座”  
Tailored Seats for Children



专用教室方案

Function Room  
& Subject Classroom

图书馆  
Library